

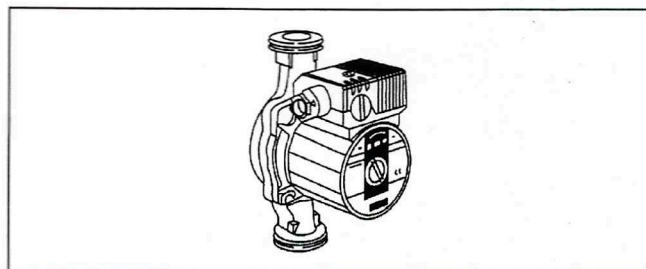

ENERGY[®]

PIPE PUMP SERIES

GB INSTALLATION AND MAINTENANCE INSTRUCTIONS



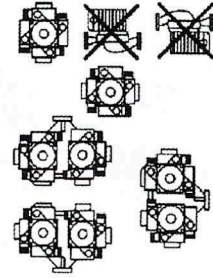

Fig.1

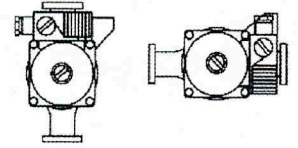

Fig.2

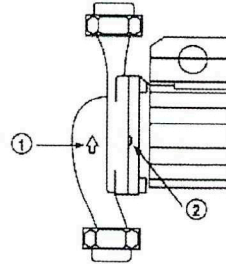

Fig.3

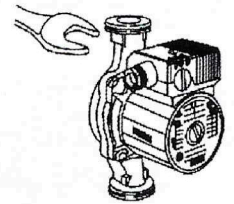
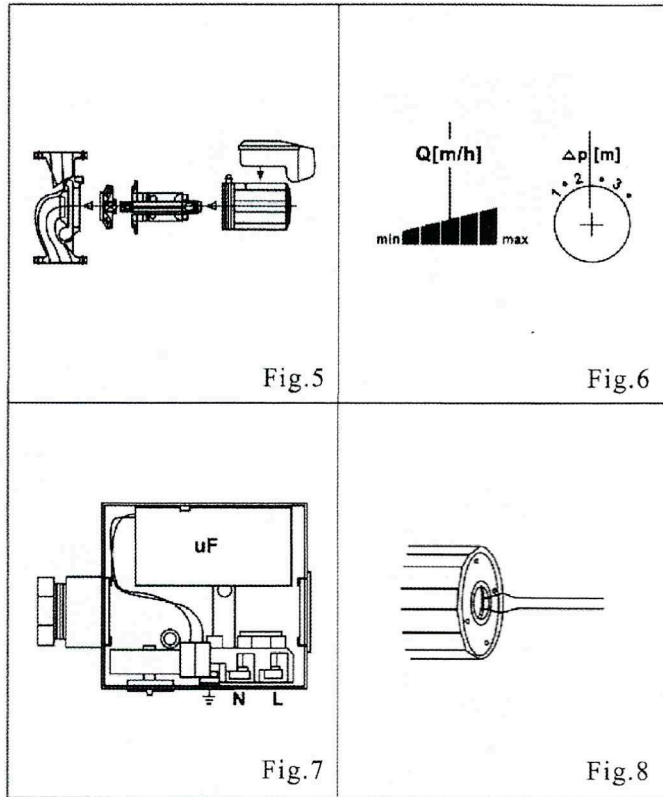

Fig.4



Safety precautions

For the operator.....	4
1 General.....	5
2 Safety Rules.....	6
3 Transport and Storage.....	8
4 Description of product and Accessories.....	8
5 Setting/Installation.....	9
6 Commissioning.....	10
7 Maintenance.....	11
8 Fault finding-Causes and Remedies.....	11
9 Spare parts.....	11

Safety precautions for the operator

Dear customer!

In this chapter entitled "Safety precautions for the operator " we would like to explain the functions and the operation of the fully installed unit. Reading the operating instructions will make it easier for you to understand the different functions of the circulating pump and how to operate them.

We would also like to remind you to read the Safety precautions in the installation and Operating Instructions carefully.

Repairs to the unit should only be carried out by trained professionals or sales department.

How the pump works .

Should the room in which the pump is situated not be heated sufficiently, the speed of the pump will be too low. In this case it is necessary to switch to a higher Speed. On the other hand, should the speed of the pump be set too high, unpleasant flowing noises will occur in the pipes and the throttled thermostatic valves . These noises can be eliminated by switching to a lower speed .

Operating the unit

The pump contains the following operating features:

Speed setting

The speed of the unit can be set using the rotary switch in the terminal box.

1 represents the lowest speed and 3 the highest .

Venting the pump

Should the heaters remain cold despite the fact that the heaters and the circulating pump are running, then it is necessary to vent the pump. When the dry well is filled with air, the pump cannot transport any water. The pump normally vents itself automatically once it has been running for a time. However, should direct manual venting be necessary. Please follow the instructions in chapter 6.1: System filling and venting, carefully.

Problems

If the fault cannot be remedied , please contact your plumbing and heating specialist or your nearest customer services or representative.

1. General

Installation and service by qualified personnel only

1.1 Field of Application

The pump is used for forced circulation of liquids in pipe systems.

The main fields of application are:

- Hot water heating systems.
- Closed industrial circulating systems.

1.2 Product data

1.2.1 Series specifications

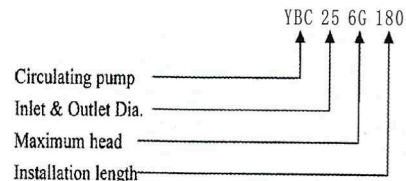

1.2.2 Connection and output data

Voltage:	1~ 240V, + 6% / - 10%, 50/60Hz
Maximum power consumption P(W):	see rating plate
Maximum motor speed:	see rating plate
System of protection:	see rating plate
Speed setting:	manual in 3 stages
Motor protection:	not necessary
Nominal diameter(DN)(pipe connection):	15mm(1/2") 20mm(3/4") 25mm(1") 32mm(1 1/4")
Installation length:	130mm 180mm
Max. permissible working pressure:	10 bar

Minimum input pressure at the intake*

at temperatures + 50°C: 0.05 bar

at temperatures +95°C 0.3 bar

at temperatures +110°C 1.0 bar

Permissible temperature range: - 10°C to + 110°C

Maximum permissible ambient temperature: +40°C

* These values are valid up to 300m above sea levels

For higher elevations add: 0.01 bar/100m.

The minimum inlet pressure must be maintained in order to avoid cavitation noise

Permissible fluids:

- Heating water to VDI 2035
- Water and water /glycol mixtures up to a ration of 1:1. Glycol mixtures require a reassessment of pump hydraulic data in line with the increased viscosity and depending on mixing ratios. Only approved makes of additives with corrosion inhibitors must be used in strict compliance with manufacturers' instructions.
- For use of other kinds of fluids consulting companies are consulted.

2 Safety Rules

These instructions contains basic reference which must be strictly adhered to. It is therefore imperative for the installer and the operator to carefully read these instructions prior to installation and commissioning.

Please observe, not only safety directions under the main heading SAFETY RULES, but also those added and specially marked under the ensuing headers.

2.1 Safety Marks contained in these instructions

Safety rules contained herein which, if not complied with, may be dangerous to persons are specially highlighted by the following danger symbols:

Danger form general causes: 

Danger form electrical causes: 

Safety references which, if not complied with, may cause damage to the pump or impair its function are highlighted by the word:

ATTENTION!

2.2 Trade Qualifications

Only suitably qualified personnel may work on this equipment.

2.3 Dangers from Non-observance of safety Rules

Non-observance of safety reference may cause bodily harm to persons or damage to the plant. Failure to comply with safety references could invalidate warranty and/or damage claims. In detail, non-compliance may, for example, cause the following dangerous situations:

-Failure of vital plant functions or damage to plant.

-Causing personal injury due to electrical and/or mechanical causes.

2.4 Safety Rules for the Operator

Local regulations for the prevention of accidents must be observed.

Danger from electrical energy must be excluded (conforming to local or general regulations such as ICE, VDE, etc.)

2.5 Safety Rules for inspections and installation Work

It is the Operator's responsibility to ensure that inspections and installation work are carried out by authorized and qualified personnel only, having themselves made fully conversant with these instructions.

Work must principally be carried out only with the plant switched off and at complete standstill.

2.6 Arbitrary Alterations and Spare Parts Procurement

Any alterations to plant are only permitted in agreement with the manufacturers.

Original spare part and authorized accessories serve safety and reliability. The use of unauthorized parts could invalidate any claims for consequential damages.

2.7 Abnormal Operating Conditions

Operational safety of the plant is only ensured if used in accordance with chapter 1 of these instruction. The limits stated there must not be exceeded under any circumstances.

3. Transport and Storage

ATTENTION!

- Pumps/plug-in modules must be protected from moisture.
- They must at no stage be subjected to temperatures outside the limits from -10°C to +50°C

4. Description of product and Accessories

4.1 Description of the Circulating Pumps

The pump is of the canned rotor type, all rotating parts are thus immersed in the fluid being handled. A shaft seal, being subject to wear and tear is not required. The fluid lubricates the shaft bearings and acts as coolant to the bearings and rotor. The pump is completely maintenance-free.

The circulating pump is an air venting pump. It is equipped with an air vent housing, suitable for use in conjunction with any commercially available automatic air vent. The housing can be rotated (by undoing the holding-down screw) to enable vertical mounting of the air vent at any pump position. Motor overload protection is not required. The motor operates non-overloading.

Speed setting

All pumps are equipped with a rotary switch in the terminal box to enable manual 3-speed control [1(min)-2-3(max)]. At minimum speed the maximum speed is reduced to approx. 40...50%. The power input is reduced to approximately 50%.

4.2 Scope of Supply

- Pump, complete
- Installation and Operating Instructions.

4.3 Accessories

- Accessories available on separate order,
- Union inserts for connection to pipe systems.

5. Setting/Installation

5.1 Installation

- Install pump only after all welding/ soldering on the pipe system is completed and the pipe system has been flushed out thoroughly to be clear of foreign matter and impurities as they may cause damage to the pump.
- Mount pump in an easily accessible condition in order to facilitate later inspection and exchange.
- To avoid draining and re-filling the whole of the pipe system on exchange of pump it is recommended to provide and install isolating valves at suction and discharge ports of the pump, to be positioned in such a way to prevent leakage dripping on the pump motor or its terminal box.
- When installed into the flow pipe of an open-vented system, the open safety vent must be connected to the system on the inlet side of the pump.
- Pump to be mounted with the shaft in the horizontal plane in such a way that it is not stressed by the pipework. Observe mounting positions as shown in Figs.2:

Fig.2: Mounting positions for Series WRS. If an automatic air vent is used, the vent housing must be rotated so to ensure its mounting vertically upwards (washers between motor/pump housing and pump housing/vent housing are identical)

When mounted in a horizontally run pipe the air venting capacity at the nominal pump duty point is approx. 25% higher than when mounted in a vertical pipe run.

- Direction of fluid flow must correspond with the arrow on the pump housing. (Fig.3, pos.1)

-When connecting the pump to the conduit of pipes, the pump can be secured against twisting using a spanner on the key surfaces which have been created for this purpose (Fig.4).

- In order to attain the correct terminal box position, the motor housing must be turned once the Allen screws have been loosened.

ATTENTION!

Take care not to damage the housing gasket (Size 86 OD×64 ID×2.0mm EP).

ATTENTION!

For units which are to be insulated, only the pump housing may be insulated. The condensation water holes on the motor flange must remain open. The motor and the condensation vents must remain free from all blockages (Fig.3, pos.2)

5.2 Electrical wiring



-Electrical work to be carried out by qualified and licensed electricians in strict conformity to ruling national conditions and local regulations.

-All wiring and external switch gear to comply with ruling local regulations (use of conduits and all-pole switches in accordance with the latest edition of IEE wiring regulations).

-In order to preserve protection against moisture entry and to ensure a firm gland grip the mains cable must have an sufficiently large outside diameter (H05 W - F3 G 1, 5)

-Heat - resisting cable must be used if the pump is installed in systems with water temperatures above 90°C.

-Cable leads to be routed in such a way to avoid any contact with pipe work or pump or stator housings.

-Check that the mains current and voltage comply with the data on the rating plate.

-Effect all wiring according to wiring diagram (Fig.5)

-Pump/installation must be earthed in compliance with regulations.

-Observe separate Installation and Operating Instructions when using automatic control gear (plug-in modules/control units).

6. Commissioning

6.1 System filling and venting

Ensure that the pipe system is properly filled and vented. The pump is normally vented automatically after a short operational period. Short-term dry-running will not harm the pump. Direct venting of the pump, if necessary, is done according to the following procedure.

-Switch-off pump

Close discharge isolating valve

carefully slacken and remove the vent plug (Fig.6)



-Beware of possibly released hot liquid or vapour, depending on fluid temperature and system pressure.

Danger of scalding exists!

-Carefully move pump shaft several times by means of a screwdriver.

Protect electrical parts from leaking water.

-Switch-on pump.

-After 15 ...30 seconds close vent plug again.

-Open isolating valve again.

ATTENTION!

It is possible that pump shaft jam with the vent plug open, depending on system pressure.



-The pump can become extremely hot, depending on the operational state of the pump or the pipe system (fluid temperature).

-Danger of scalding exists when touching the pump!

7. Maintenance

The pump is maintenance-free.

8. Fault Finding-Causes and Remedies

8.1 Pump is switched on, but fails to run:

-Check power supply fuses.

-Check voltage at pump terminals (refer to name plate data).

-Check capacitor size (refer to name plate data).

-Rotor shaft has jammed e.g. by instructions from the heating water.

Remedy: Remove central vent plug, check free movement of shaft or free respectively at the slotted shaft end by means of a screwdriver(Fig.6)



-At high water temperatures and system pressures, close isolating valves at both pump ports. First, allow pump to cool down.

8.2 Noise

-Cavitation due to insufficient inlet pressure Remedial actions:

-Increase system pressure within permissible limits.

-Check speed setting, if need be, adjust to a lower speed setting.

If the fault cannot be located or rectified, please contact your nearest representative.

9. Spare Parts

All name plate data must be stated when ordering spare parts.

Technical modifications reserved.

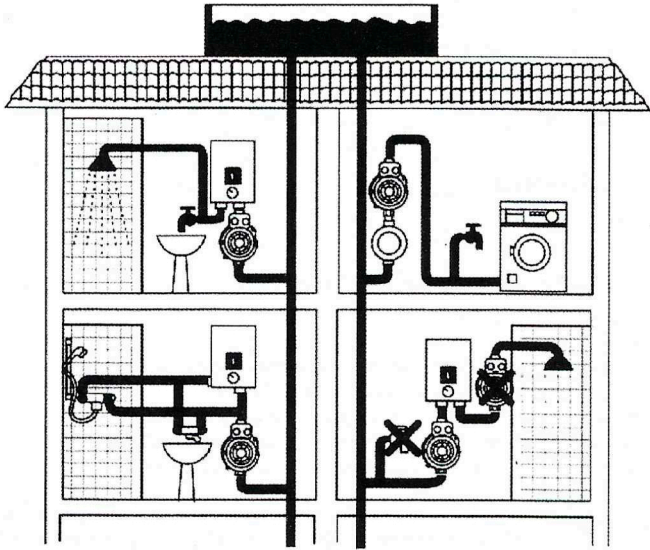

- Don't fix the water pump beside the outlet of the water heater.
- Don't fix the hydrant beside the inlet of the water pump.